

- NOTES:
 1. ALL DIMENSIONS FOR REFERENCE ONLY
 2. REFER TO AIR LOGIC'S POLYSULFONE APPLICATION GUIDE
 3. TUBE RETENTION PRESSURE SUBJECT TO TUBING DIMENSION AND STIFFNESS

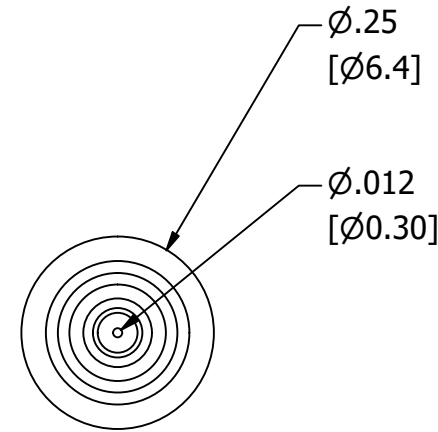

BARBED CONNECTION FOR 1/8" [3.2] I.D. TUBE,
 FIRST BARB FREE OF PARTING LINE

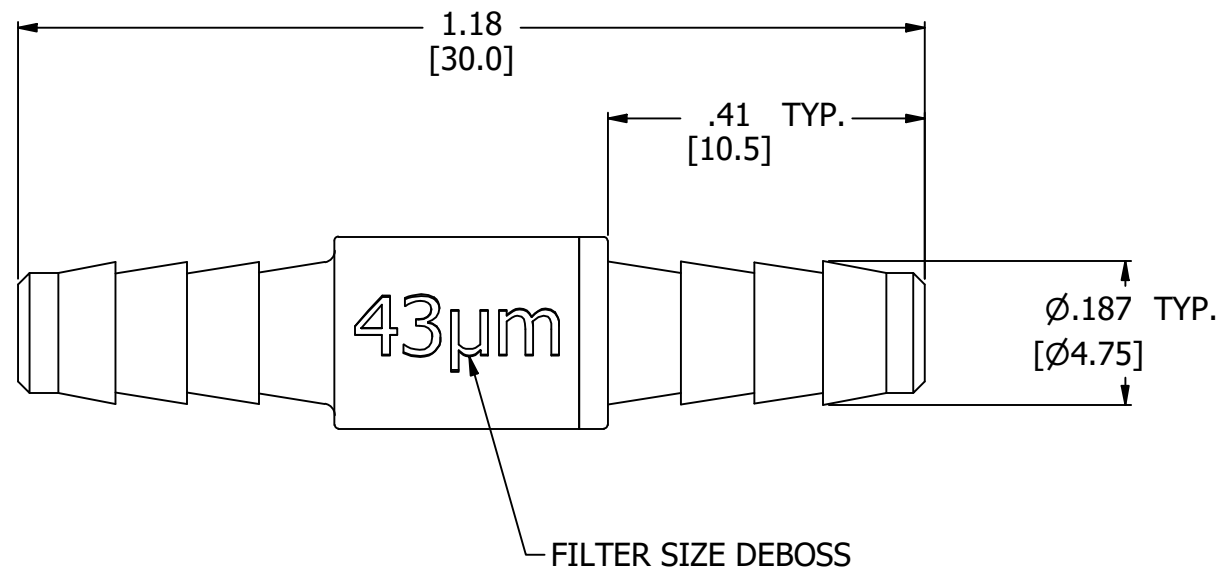
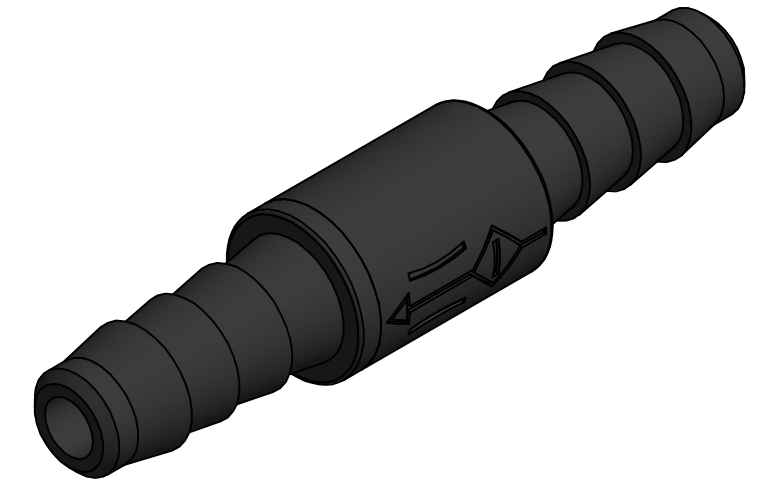
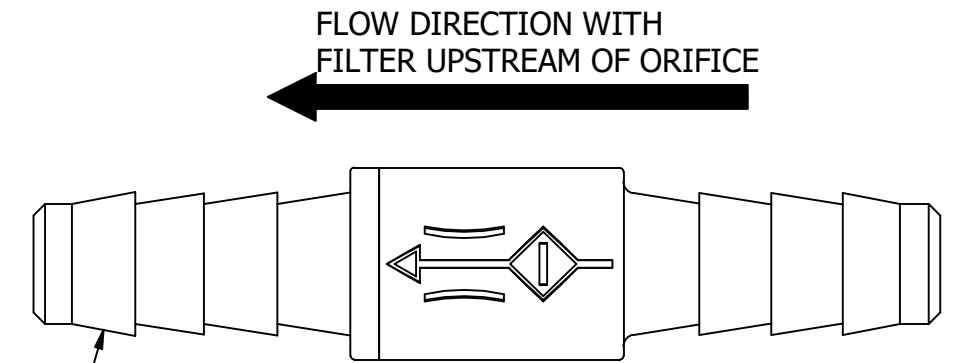

PRODUCT SPECIFICATIONS

COLOR(S)	BLACK
FILTER SIZE	43 MICRON
MEDIA	GASES, LIQUIDS, NOTE 2
MAX INLET PRESSURE	125 PSI, [8.6 BAR]
TYPICAL TUBE RETENTION PRESSURE	125 PSI, [8.6 BAR], NOTE 3
NOMINAL ORIFICE DIAMETER	Ø.012, [Ø0.30]
WETTED MATERIALS	POLYSULFONE, STAINLESS STEEL

 **AIR-LOGIC** @ DIVISION OF KNAPP MFG, INC.
 5102 DOUGLAS AVE RACINE, WI 53402
 PHONE: (262) 639-9035 FAX: (262) 639-5996 WEB: AIR-LOGIC.COM

PART/DRAWING NO.:

F95043121B85

DESCRIPTION:
 FILTERED ORIFICE RESTRICTOR, Ø.012, 43 MICRON FILTER,
 1/8" BARBS

REVISION: B	DRAWN: 2/24/2021
SCALE: 4 : 1	SHEET SIZE: B

TERMS OF USE:
 THIS DRAWING IS FOR INFORMATIONAL PURPOSES ONLY. AIR LOGIC MAKES
 NO REPRESENTATIONS OF WARRANTIES CONCERNING SUITABILITY FOR ANY
 PARTICULAR PURPOSE. ALL PRODUCTS SUPPLIED ARE SUBJECT TO TERMS
 AND CONDITIONS FOUND AT AIR-LOGIC.COM

DRAWING TAKES PRECEDENCE OVER 3D MODEL GEOMETRY
 TOLERANCE: DECIMALS .00 ± .01, .000 ± .005, FRACTIONS ± 1/64
 ANGLES 1/4° UNLESS OTHERWISE SPECIFIED
 UNITS: INCHES [MILLIMETERS]