

NOTES:

1. ALL DIMENSIONS FOR REFERENCE ONLY
2. REFER TO AIR LOGIC'S POLYSULFONE APPLICATION GUIDE
3. TUBE RETENTION PRESSURE SUBJECT TO TUBING DIMENSION AND STIFFNESS

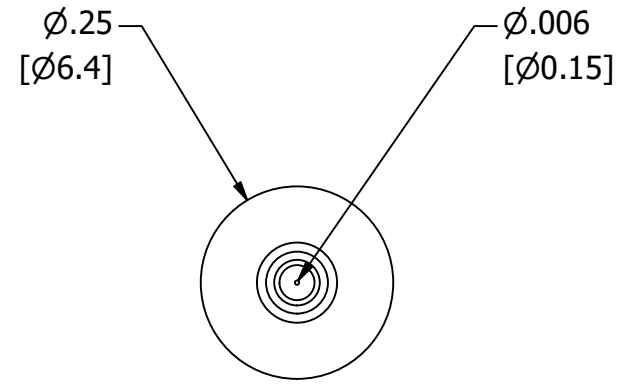
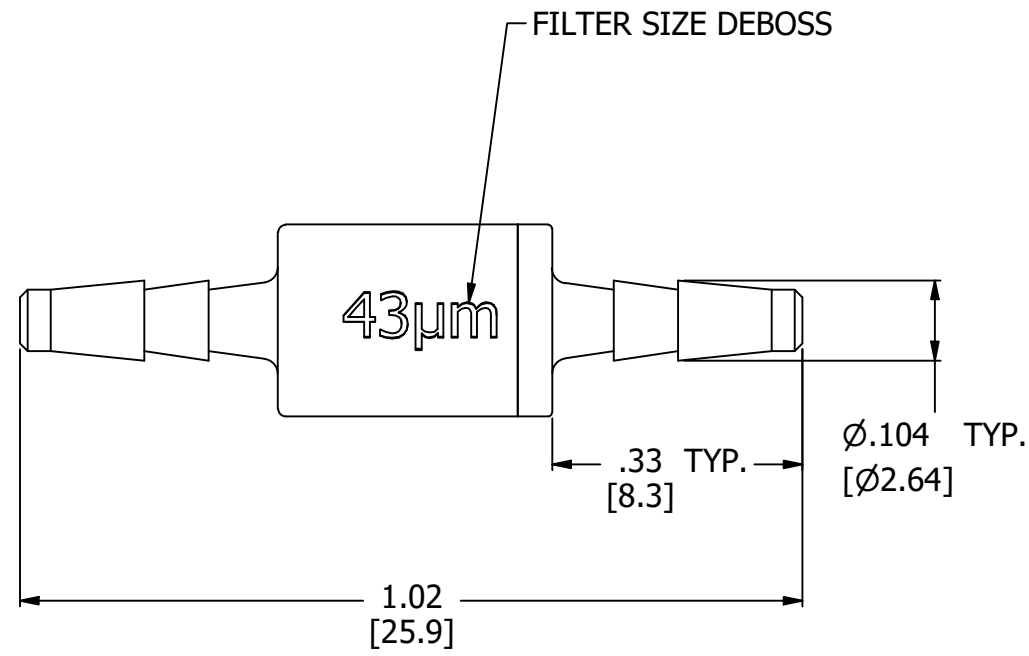
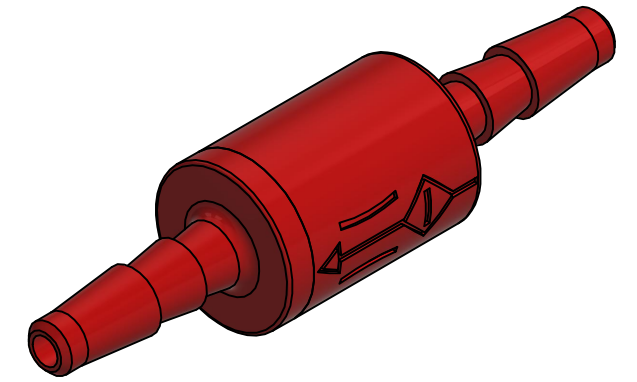

BARBED CONNECTION FOR 1/16" [1.6] I.D. TUBE,
FIRST BARB FREE OF PARTING LINE

FLOW DIRECTION WITH
FILTER UPSTREAM OF ORIFICE

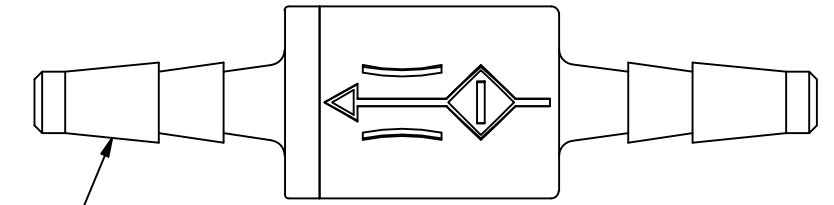

PRODUCT SPECIFICATIONS

COLOR(S)	RED
FILTER SIZE	43 MICRON
MEDIA	GASES, LIQUIDS, NOTE 2
MAX INLET PRESSURE	125 PSI, [8.6 BAR]
TYPICAL TUBE RETENTION PRESSURE	125 PSI, [8.6 BAR], NOTE 3
NOMINAL ORIFICE DIAMETER	Ø.006 [Ø0.15]
WETTED MATERIALS	POLYSULFONE, STAINLESS STEEL



AIR-LOGIC @ DIVISION OF KNAPP MFG, INC.
5102 DOUGLAS AVE RACINE, WI 53402
PHONE: (262) 639-9035 FAX: (262) 639-5996 WEB: AIR-LOGIC.COM

PART/DRAWING NO.:

F95043051B80

DESCRIPTION:
FILTERED ORIFICE RESTRICTOR, Ø.006, 43 MICRON FILTER,
1/16" BARBS

REVISION: B DRAWN: 2/24/2021

SCALE: 4 : 1 SHEET SIZE: B

TERMS OF USE:
THIS DRAWING IS FOR INFORMATIONAL PURPOSES ONLY. AIR LOGIC MAKES
NO REPRESENTATIONS OF WARRANTIES CONCERNING SUITABILITY FOR ANY
PARTICULAR PURPOSE. ALL PRODUCTS SUPPLIED ARE SUBJECT TO TERMS
AND CONDITIONS FOUND AT AIR-LOGIC.COM

DRAWING TAKES PRECEDENCE OVER 3D MODEL GEOMETRY
TOLERANCE: DECIMALS .00 ± .01, .000 ± .005, FRACTIONS ± 1/64
ANGLES 1/4° UNLESS OTHERWISE SPECIFIED
UNITS: INCHES [MILLIMETERS]